

- 1 Day
- 2 Desired (set) temperature
- 3 Heat on/off
- 4 Night
- 5 Function key
- 6 Day temperature cutback (5 days)
- 7 Night temperature cutback (7 days)

A brief description of the H30 heater's functions

There are three modes to choose from:

- 1 **HO** (Home) is suitable for private homes. It allows you to choose automatic temperature cutback at night and during weekdays. At the weekend there will be no daytime cutback.
- 2 **OF** (office) mode is suitable for offices and rooms used similarly. This mode gives you temperature cutback at night and from Friday evening to Monday morning. If working overtime, you may easily override the cutback.
- 3 **CA** (Cabin) mode allows you keep a low, cutback temperature when the cabin is not in use, and the system will switch to comfort temperature for your arrival. Periods of temperature cutback may last from 1 to 40 days continuously. However the cutback period you have selected will repeat itself automatically after 48 hours of comfort temperature.

Once made, settings are easily overridden, and you are free to select the temperature and duration of the cutback periods to meet your particular requirements.

HOME MODE (HO)

Startup and Reset - must be carried out after a long power cut or at first time use.

A Startup/Reset procedure has to be performed to initiate the correct mode and function of the heater.

IMPORTANT: there are two different startup sequences

- 1) If °C-17-rE is flashing in the display: go to procedure A.
- 2) If HO is flashing in the display: go to procedure B.

The procedure must be completed in one continuous sequence to be valid. Should the procedure be performed incorrectly or fail, switch off the heater and start a new reset procedure.

Startup procedure A – if the heater has been connected and switched on beforehand:

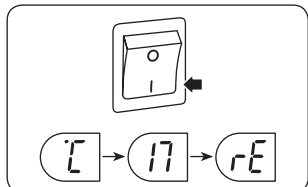

On switching heater on, the sequence °C – 17 – rE - will flash in the display. This means that the thermostat has been disconnected for a long period and needs to be restarted.

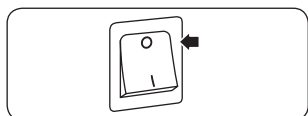

To set the heater back to the factory default, switch off the heater using the main switch.

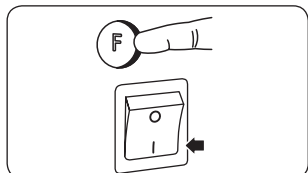

Press and hold in (F) and then switch on using the main power switch.

Continue to press (F) until rE flashes in the display, then release (F).



After a few seconds HO will flash in the display.

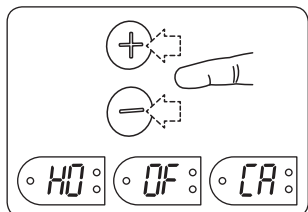

You can choose between the modes HO, OF (Office) and CA (Cabin) by pressing the (+) or (-) key.

Confirm your choice by pressing in the (F) key for more than 5 seconds.

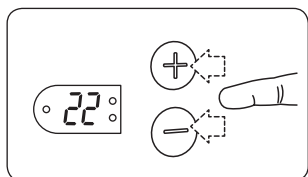

22 (°C) will flash. Select your preferred comfort temperature.

Confirm by pressing in the (F) key for more than 5 seconds.

If you do nothing, 22 (°C) will automatically be stored after 7 seconds.

Startup procedure B – if the heater has never been switched on since leaving the factory:

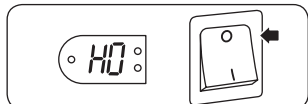

When the heater is switched on, HO (Home mode) will flash in the display.

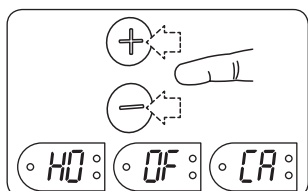

You can select between modes HO, OF (Office) and CA (Cabin) by pressing the (+) or (-) key.

Confirm your choice by pressing in (F) key for more than 5 seconds.

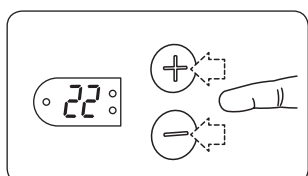

22 (°C) will flash. Select your preferred comfort temperature.

Confirm by pressing in the (F) key more than 5 seconds.

If you do nothing, 22 (°C) will automatically be stored after 7 seconds.

Start nighttime temperature cutback

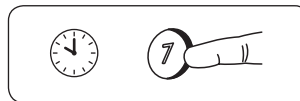

At the time you wish temperature cutback to start, press (7) for 5 seconds.

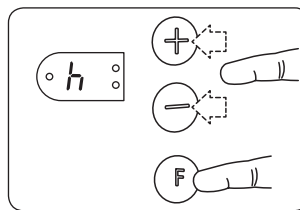

h (hours) will flash 3 times and then 07 will flash continuously.

With the (+) or (-) key select the number of hours you want the cutback to last.

Confirm by pressing the (F) key briefly.

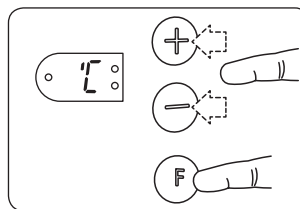

°C will flash 3 times and then 17 (°C) will flash continuously.

Using the (+) or (-) key select the cutback temperature.

Confirm by pressing (F) key briefly.

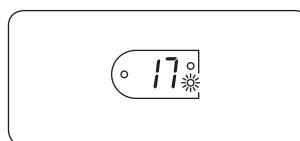

The green lamp (4) will now flash slowly to indicate that temperature cutback is active.

The temperature is reduced for the number of hours you have chosen.

This will be repeated for the same period every night.

Start daytime temperature cutback



At the time you wish temperature cutback to start, press (5) for 5 seconds.

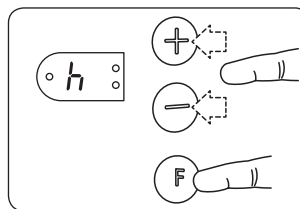

h (hours) will flash 3 times and then 05 will flash continuously.

Using the (+) or (-) key, select the number of hours you want the temperature cutback to last.

Confirm by pressing the (F) key briefly.

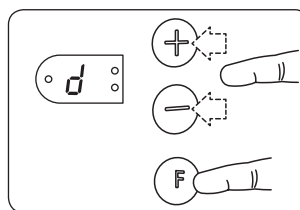

d will flash 3 times and then a random number.

Using the (+) or (-) key, enter the correct day of the week (Monday = 1, etc.).

Confirm by pressing the (F) key briefly.

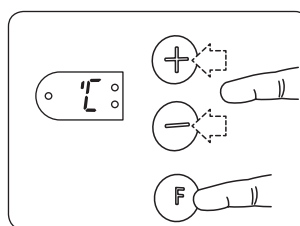

°C will flash 3 times and then 17 (°C) will flash continuously.

With (+) or (-) key select your preferred cutback temperature.

Confirm by pressing (F) key briefly.

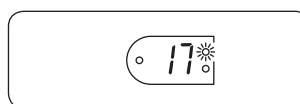

The green lamp (1) will now flash slowly to indicate that temperature cutback is active.

The temperature is reduced for the number of hours you have chosen. This will be repeated at the same times from Monday to Friday, leaving Saturday and Sunday unaffected.

Canceling a period of temperature cutback

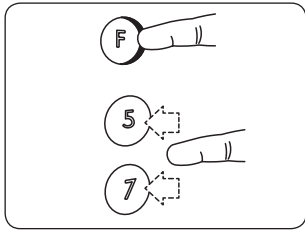

Hold down **F** and press once on **7** or **5** to override the current active period, or the next period of temperature cutback. The lamp is lit steadily for the period in question. Temperature cutback will resume as usual from the subsequent period.

Temperature override

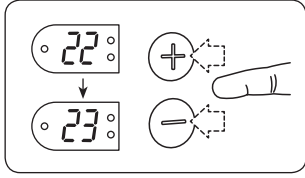

Selecting another temperature during either a comfort or cutback period, without storing it (by pressing **F** for 5 seconds), will apply only to the current period.

Change the temperature setting (comfort or cutback)

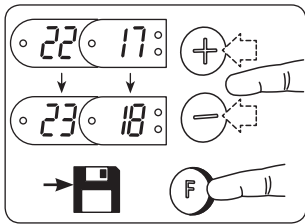

When in the comfort or cutback temperature mode, choose your new comfort or cutback temperature by pressing **+** or **-**.

Save the setting by pressing **F** more than 5 seconds.

Change the duration of temperature cutback and/or the cutback temperature

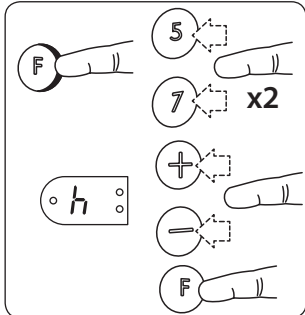

Hold down on **F** and press twice on **7** or **5**. Release **F** and h (hours) will flash 3 times.

Using the **+** or **-** key select the number of hours you want the cutback to last.

Confirm by pressing **F** key briefly.

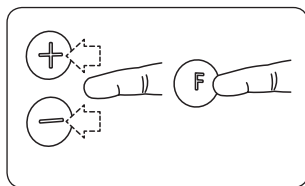

If you have first pressed **5** to change the daytime cutback settings, d will now flash three times and a random number is displayed. Use the **+** or **-** key to select the correct day (Monday = 1, etc.). Confirm by pressing **F** briefly.

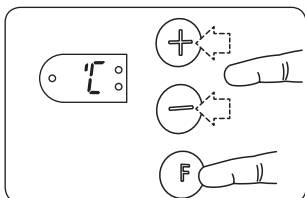

°C will flash 3 times and then the current cutback temperature will flash.

With **+** or **-** key select the cutback temperature.

Confirm by pressing **F** key briefly.

Permanently delete cutback function

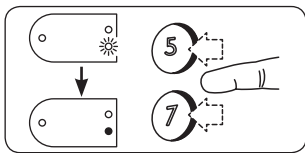

To permanently delete a temperature cutback function, press **7** or **5** until the green lamp goes out.

Child lock

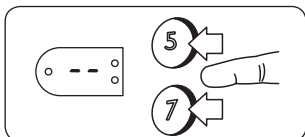

To lock: Press **7** and **5** at the same time until you see -- in the display.

To unlock: Press **7** and **5** at the same time until you see -- disappear in the display.

Calibration

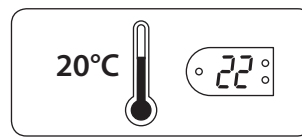

Should the actual room temperature and the H30's setting not correspond, the H30 should be calibrated.

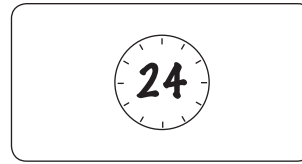

First let the heater work at the same temperature setting, preferably for at least 24 hours, keeping doors and windows closed. This makes certain that the H30 that is regulating room temperature.

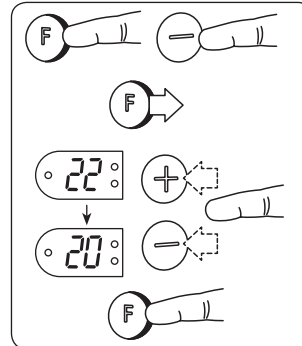

Hold down on **F** and press once on **-**. Release **F**. °C will flash 3 times and the setpoint temperature will flash. Press **+** or **-** until the display shows the same as the actual measured room temperature. Store by pressing **F** for 5 seconds.

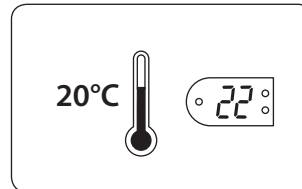

The heater will now work with the temperature displayed by the H30 and after a period this will correspond with the actual temperature of the room. This procedure can be repeated at a later date to ensure correct calibration.

Reset the thermostat to factory default values

Nb! Reset is not possible if the thermostat display is in any flashing mode.

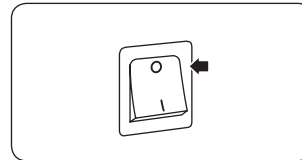

After resetting, the thermostat has to be reprogrammed according to the instructions for your chosen mode. Switch the heater OFF.

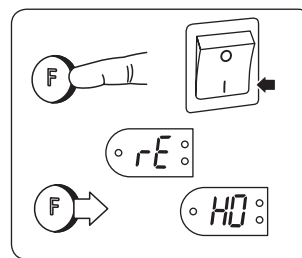

Hold in the **F** key and then switch the heater ON.

Hold the **F** key in for more than 5 seconds until rE starts flashing in the display.

Release **F** and HO (Home Mode) will flash.

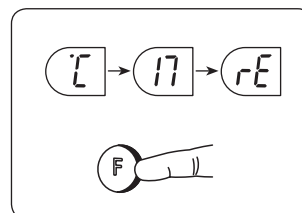

You can select between modes HO, OF (Office) and CA (Cabin) by pressing the **+** or **-** keys.

Confirm your choice by pressing the **F** key for more than 5 seconds.

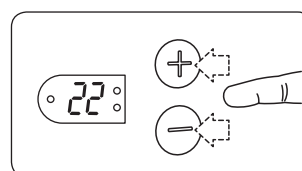

22 (°C) will flash. Select your preferred comfort temperature.

Confirm by pressing in the **F** key for more than 5 seconds.

If you do nothing, 22 (°C) will automatically be stored after 7 seconds.

OFFICE MODE (OF)

Startup and Reset – must be carried out after a long power cut or at first time use.

A Startup/Reset procedure has to be performed to initiate the correct mode and function of the heater.

IMPORTANT: there are two different startup sequences

- 1) If °C-17-rE is flashing in the display: go to procedure A.
- 2) If HO is flashing in the display: go to procedure B.

The procedure must be completed in one continuous sequence to be valid. Should the procedure be performed incorrectly or fail, switch off the heater and start a new reset procedure.

Startup procedure A – if the heater has been connected and switched on beforehand:

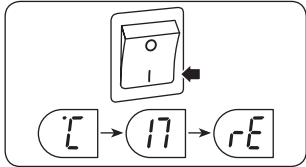

On switching heater on, the sequence °C – 17 – rE - will flash in the display.

This means that the thermostat has been disconnected for a long period and needs to be restarted.

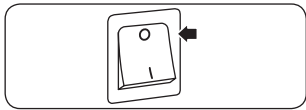

To set the heater back to the factory default, switch off the heater using the main power switch.

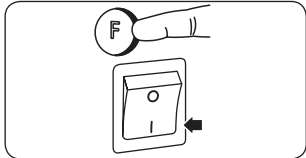

Press **F** and hold in and at the same time switch on using the main power switch.

Continue to press **F** until rE flashes in the display, then release **F**.



After a few seconds HO will flash in the display.

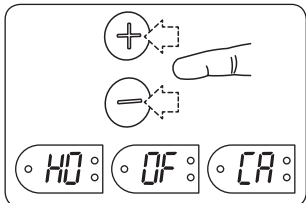

You can choose between the modes HO (Home), OF (Office) and CA (Cabin) by pressing the **+** or **-** key.

Confirm your choice by holding in the **F** key for more than 5 seconds.

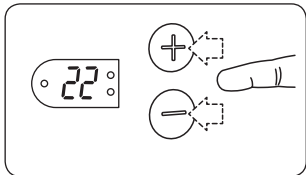

22 (°C) will flash. Select your preferred comfort temperature.

Confirm by holding in the **F** key for more than 5 seconds.

If you do nothing, 22 (°C) will be stored automatically after 7 seconds.

Startup procedure B – if the heater has never been switched on since leaving the factory:

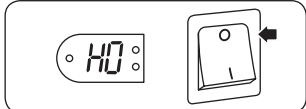

When the heater is switched on, HO (Home mode) will flash in the display.

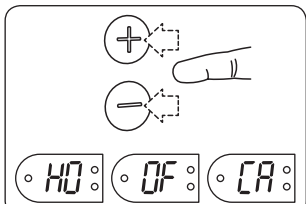

You can select between modes HO, OF (Office) and CA (Cabin) by pressing the **+** or **-** key.

Confirm your choice by pressing in **F** key for more than 5 seconds.

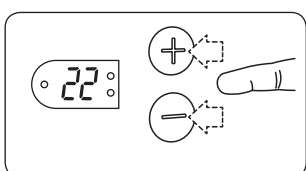

22 (°C) will flash. Select your preferred comfort temperature.

Confirm by pressing in the **F** key more than 5 seconds.

If you do nothing, 22 (°C) will be stored automatically after 7 seconds.

Starting the temperature cutback function

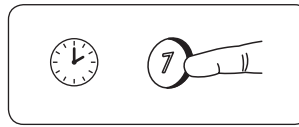

Three hours before you usually leave the office press down on **7** for 5 seconds (e.g. At 14:00 – 2 PM – press **7** for 5 seconds).

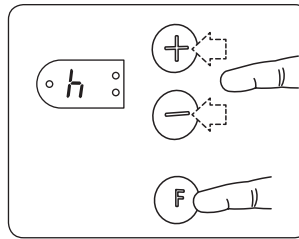

h (hours) will flash for three seconds, then 12 (hours) will flash. Select the number of hours you want cutback to be active by pressing **+** or **-**.

(NB! Cutback will start after three hours.) Confirm by pressing **F** briefly.

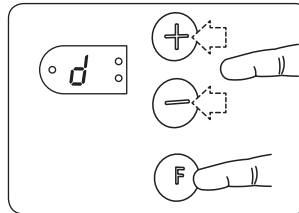

d (day) will be displayed steadily for three seconds. Then a random number will flash (1 = Monday, 2 = Tuesday, etc). Select the correct day using **+** or **-** and confirm by pressing **F** briefly.

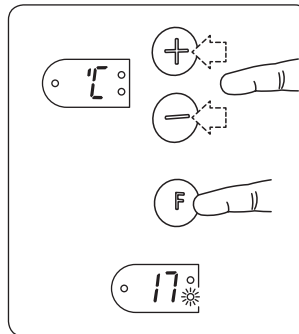

°C will flash three times and then 17 (°C) will flash continuously. With the **+** or **-** key select your preferred cutback temperature.

Confirm by pressing **F** key briefly.

Comfort temperature will continue for three hours before the cutback starts automatically.

(E.g. At 17:00 – 5 PM – the cutback period will start and the LED (1) will flash slowly.)

Cutback indicator



During the cutback period the LED (1) will flash slowly. When it is lit steadily, it indicates that cutback function is not currently active but will start at the appropriate time of the evening.

Working overtime

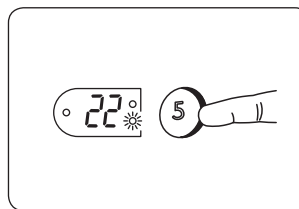

Press **5** for 5 seconds. The set comfort temperature will show in the display. The LED above the **5** key will light steady while the LED above the **7** key will continue flashing. You now have a temporary comfort period lasting five hours.

To cancel a period of temperature cutback

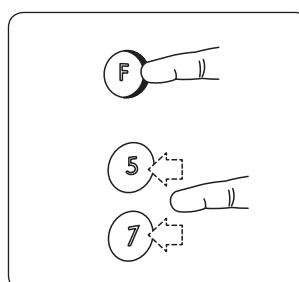

Hold down on **F** and press once on **7** to override the currently active period – or the next period of temperature cutback. The lamp is lit steadily for the period in question. Temperature cutback periods will resume as usual from the following period.

Temperature override

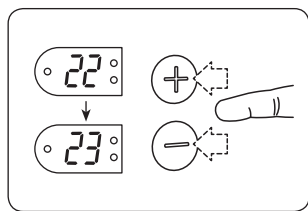

If you select another temperature during either a comfort or a cutback period, and do not save (by pressing **F** for five seconds), the new temperature will apply only to the current period.

To select a new cutback temperature setting

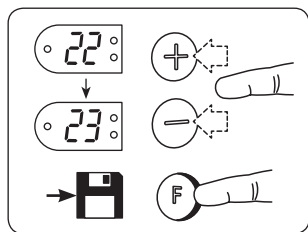

While cutback temperature is ongoing, choose the desired new cutback temperature by pressing **+** or **-**. Save the setting by pressing **F** more than five seconds.

Change the duration of temperature cutback and/or the cutback temperature

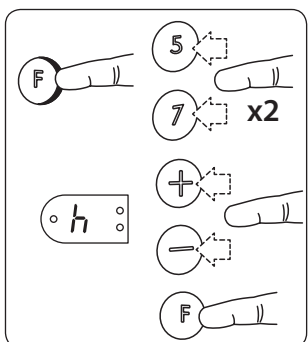

Hold down on **F** and press twice on **7** or **5**. Release **F** and h (hours) will flash 3 times.

Using the **+** or **-** key select the number of hours you want the cutback to last.

Confirm by pressing **F** key briefly.

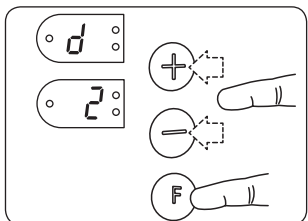

d (day) will be displayed for three seconds, and afterwards a random number.

Using the **+** and **-** keys, select the correct weekday (Monday = 1 etc.).

Press **F** briefly to confirm.

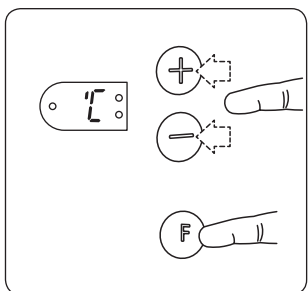

°C will flash 3 times and then the current cutback temperature will flash.

With **+** or **-** key select the cutback temperature.

Confirm by pressing **F** key briefly.

Permanently delete cutback function

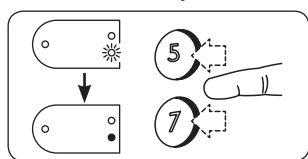

To permanently delete a temperature cutback function, press **7** or **5** until the green lamp goes out.

Child lock

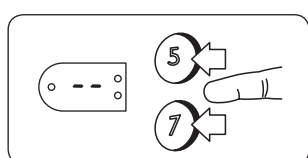

To lock: Press **7** and **5** at the same time until you see -- in the display.

To unlock: Press **7** and **5** at the same time until you see -- disappear in the display.

Calibration

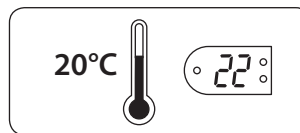

Should the actual room temperature and the H30's setting not correspond, the H30 should be calibrated.

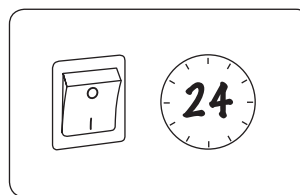

First let the heater work at the same temperature setting, preferably for at least 24 hours, keeping doors and windows closed. This makes certain that the H30 that is controlling room temperature.

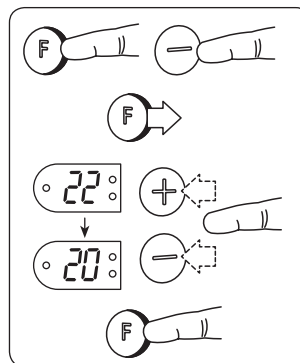

Hold down on **F** and press once on **-**. Release **F**. °C will flash 3 times and the setpoint temperature will flash. Press **+** or **-** until the display shows the same as the actual measured room temperature. Store by pressing **F** for 5 seconds.

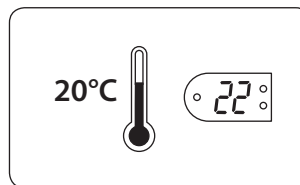

The heater will now work with the temperature displayed by the H30 and after a period this will correspond with the actual temperature of the room. This procedure can be repeated at a later date to ensure correct calibration.

Reset the thermostat to factory default values

Nb! Reset is not possible if the thermostat display is in any flashing mode.

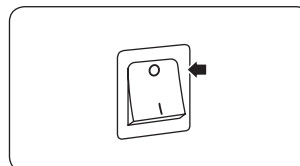

After resetting, the thermostat has to be reprogrammed according to the instructions for your chosen mode. Switch the heater OFF.

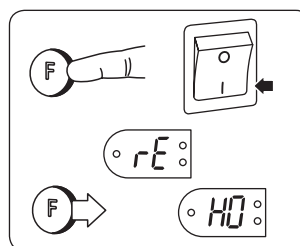

Hold in the **F** key and then switch the heater ON.

Hold the **F** key in for more than 5 seconds until rE starts flashing in the display.

Release **F** and HO (Home Mode) will flash.

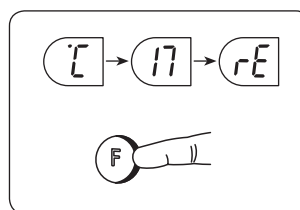

You can select between modes HO, OF (Office) and CA (Cabin) by pressing the **+** or **-** keys.

Confirm your choice by pressing the **F** key for more than 5 seconds.

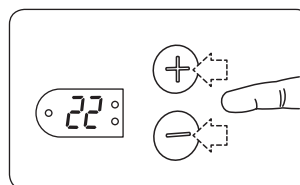

22 (°C) will flash. Select your preferred comfort temperature.

Confirm by pressing in the **F** key for more than 5 seconds.

If you do nothing, 22 (°C) will automatically be stored after 7 seconds.

CABIN MODE (CA)

Important to know! In cabin mode any temperature you select will be automatically saved.

The reason: Should someone leave the cabin having selected a low, frost-safe temperature without any further action, this setting will be saved and will continue after a power cut, whatever its length. This will ensure that unattended periods will always have a low temperature setting, and energy consumption will stay at a minimum. After a long power cut the heater will start up with the lower temperature setting, whether it is the comfort or the cutback value.

Startup and Reset - must be carried out after a long power cut or at first time use.

A Startup/Reset procedure has to be performed to initiate the correct mode and function of the heater.

IMPORTANT: there are two different startup sequences

- 1) If °C-17-rE is flashing in the display: go to procedure A.
- 2) If HO is flashing in the display: go to procedure B.

The procedure must be completed in one continuous sequence to be valid. Should the procedure be performed incorrectly or fail, switch off the heater and start a new reset procedure.

Startup procedure A – if the heater has been connected and switched on beforehand:

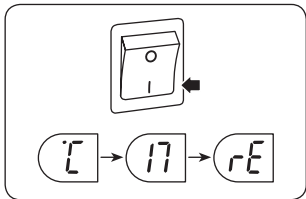

On switching heater on, the sequence °C – 17 – rE - will flash in the display.

This means that the thermostat has been disconnected for a long period and needs to be restarted.

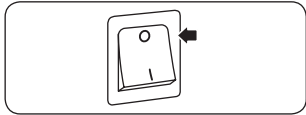

To set the heater back to the factory default, switch off the heater using the main power switch.

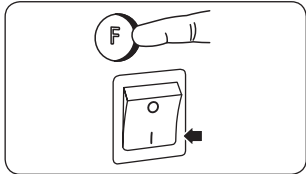

Press **F** and hold in and at the same time switch on using the main power switch.

Continue to press **F** until rE flashes in the display, then release **F**.



After a few seconds HO will flash in the display.

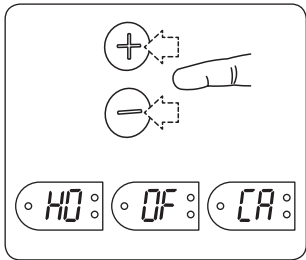

You can choose between the modes HO (Home), OF (Office) and CA (Cabin) by pressing the **+** or **-** key.

Confirm your choice by holding in the **F** key for more than 5 seconds.

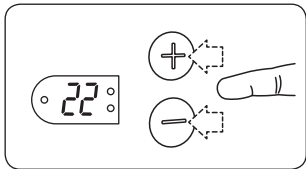

22 (°C) will flash. Select your preferred comfort temperature.

Confirm by holding in the **F** key for more than 5 seconds.

If you do nothing, 22 (°C) will be stored automatically after 7 seconds.

Startup procedure B – if the heater has never been switched on since leaving the factory:



When the heater is switched on, HO (Home mode) will flash in the display.

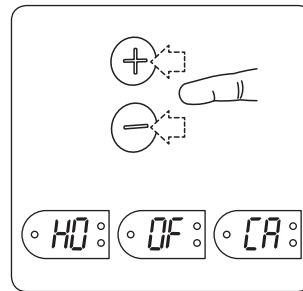

You can select between modes HO, OF (Office) and CA (Cabin) by pressing the **+** or **-** key.

Confirm your choice by pressing in **F** key for more than 5 seconds.

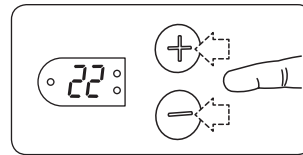

22 (°C) will flash. Select your preferred comfort temperature.

Confirm by pressing in the **F** key more than 5 seconds.

If you do nothing, 22 (°C) will be stored automatically after 7 seconds.

Starting the temperature cutback function

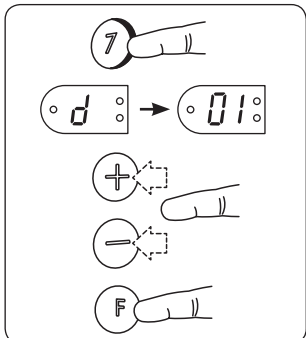

Press **7** for 5 seconds. d (days) will flash 3 times. 01 (days) will flash continuously.

Select the number of days you want the period to last by pressing the **+** or **-** key. (The number can be from 01 to 40 days)

Confirm by pressing **F**.

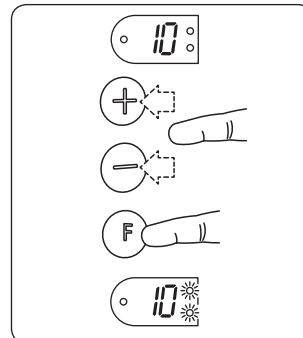

10 (°C) will flash.

Select the frost-safe temperature with the **+** or **-** key.

Confirm by pressing **F**.

The frost-safe temperature will be displayed and LEDs 7 and 5 will flash slowly.

When the temperature cutback period ends

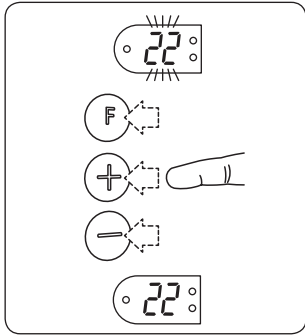

At the time the frost-safe period ends, the comfort temperature setting will flash to indicate the need for action.

Press any key to make the comfort temperature display steadily and that temperature will now continue.

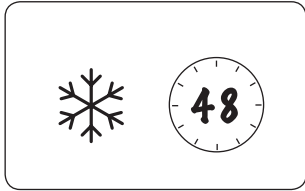

If you do nothing while the display is flashing, another frost-safe period will start automatically after 48 hours.

Cancelling a frost-safe period

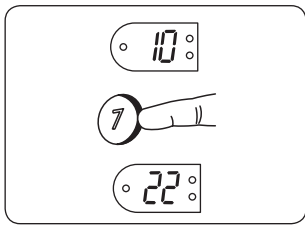

To end an ongoing frost-safe period, press 7 for more than 5 seconds.

Selecting a new cutback temperature setting

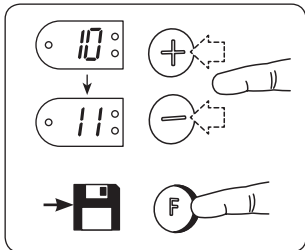

When cutback temperature is ongoing, select the new cutback temperature you desire by pressing + or -. Save the setting by pressing F more than 5 seconds.

Child lock

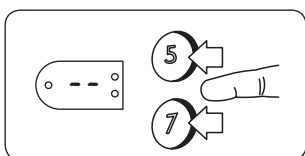

To lock: Press 7 and 5 at the same time until you see -- in the display.

To unlock: Press 7 and 5 at the same time until you see -- disappear in the display.

Calibration

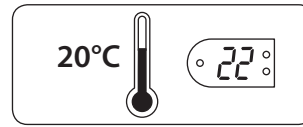

Should the actual room temperature and the H30's setting not correspond, the H30 should be calibrated.

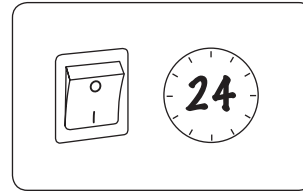

First let the heater work at the same temperature setting, preferably for at least 24 hours, keeping doors and windows closed. This makes certain that the H30 that is controlling room temperature.

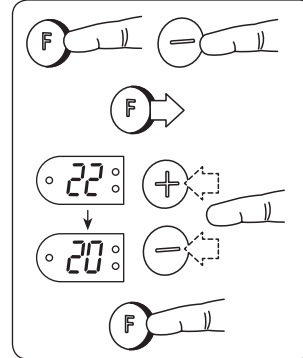

Hold down on F and press once on -. Release F. °C will flash 3 times and the setpoint temperature will flash. Press + or - until the display shows the same as the actual measured room temperature. Store by pressing F for 5 seconds.

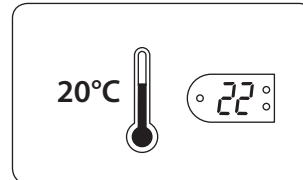

The heater will now work with the temperature displayed by the H30 and after a period this will correspond with the actual temperature of the room. This procedure can be repeated at a later date to ensure correct calibration.

Reset the thermostat to factory default values

Nb! Reset is not possible if the thermostat display is in any flashing mode.

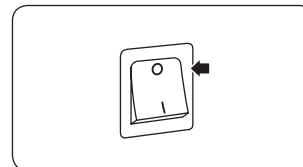

After resetting, the thermostat has to be reprogrammed according to the instructions for your chosen mode. Switch the heater OFF.

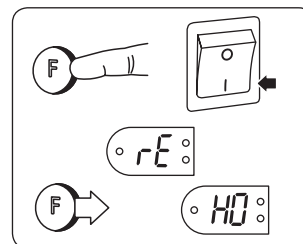

Hold in the F key and then switch the heater ON.

Hold the F key in for more than 5 seconds until rE starts flashing in the display.

Release F and HO (Home Mode) will flash.

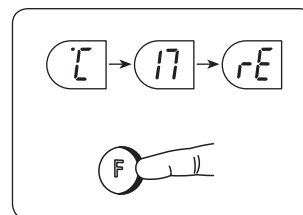

You can select between modes HO, OF (Office) and CA (Cabin) by pressing the + or - keys.

Confirm your choice by pressing the F key for more than 5 seconds.

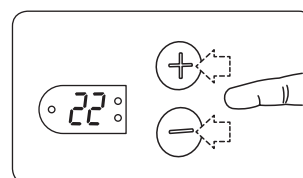

22 (°C) will flash. Select your preferred comfort temperature.

Confirm by pressing in the F key for more than 5 seconds.

If you do nothing, 22 (°C) will automatically be stored after 7 seconds.

The appliance is not intended for use by persons (including children) with reduced physical, sensory or mental capabilities, or lack of experience and knowledge, unless they have been given supervision or instruction concerning the use of the appliance by a person responsible for their safety.

Children should be supervised to ensure they do not play with the appliance.

If the supply cord is damaged, it must be replaced by the manufacturer, its service agent or similarly qualified persons in order to avoid a hazard.

www.adax.no